



DATASHEET

RG2

v1.3

1. Datasheet

1.1. RG2

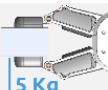
General Properties	Minimum	Typical	Maximum	Unit
 Payload Force Fit 2 Kg	-	-	2	[kg]
	-	-	4.4	[lb]
 Payload Form Fit 5 Kg	-	-	5	[kg]
	-	-	11	[lb]
Total stroke (adjustable)	0	-	110	[mm]
	0	-	4.33	[inch]
Finger position resolution	-	0.1	-	[mm]
	-	0.004	-	[inch]
Repetition accuracy	-	0.1	0.2	[mm]
	-	0.004	0.007	[inch]
Reversing backlash	0.1	-	0.3	[mm]
	0.004	-	0.011	[inch]
Gripping force (adjustable)	3	-	40	[N]
Gripping force deviation		±25		%
Gripping speed *	38	-	127	[mm/s]
Gripping time **	0.06	-	0.21	[s]
Adjustable bracket tilting accuracy	-	< 1	-	°
Storage temperature	0	-	60	[°C]
	32	-	140	[°F]
Motor	Integrated, electric BLDC			
IP Classification	IP54			
Dimensions	213 x 149 x 36			[mm]
	8.3 x 5.9 x 1.4			[inch]
Weight	0.78			[kg]
	1.72			[lb]

* See table on the next page

** based on 8mm total movement between fingers. The speed is linearly proportional to the force. For more details see speed table on next page.

Operating Conditions	Minimum	Typical	Maximum	Unit
Power supply	20	24	25	[V]
Current consumption	70	-	600*	[mA]
Operating temperature	5	-	50	[°C]
	41	-	122	[°F]
Relative humidity (non-condensing)	0	-	95	[%]
Calculated operation life	30 000	-	-	[Hours]

* Current spikes up to 3A (max 6mS) may occur during the release action.

RG2 Gripping Speed Graph

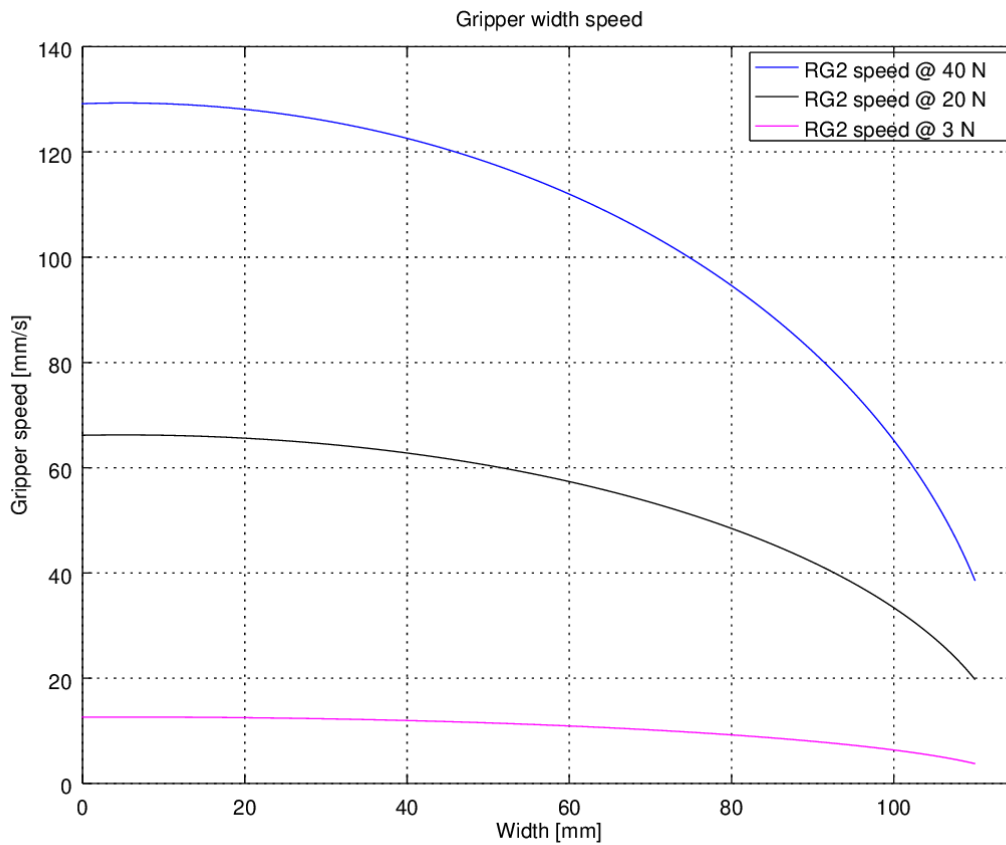

RG2 Work Range

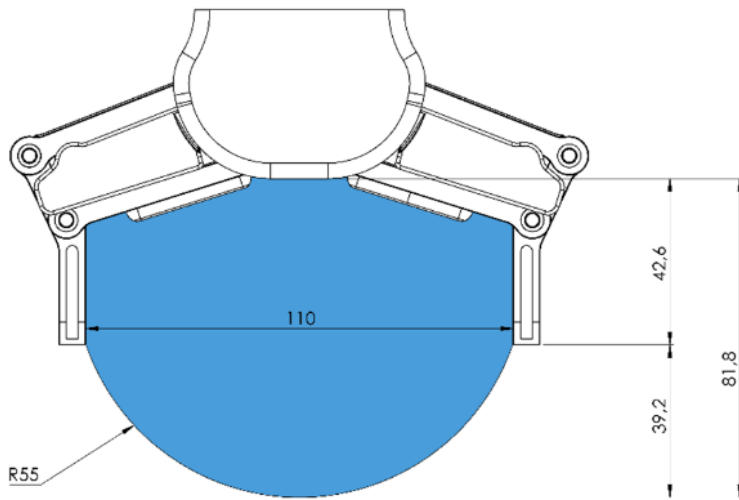

Gripping on long objects can unintentionally activate the Safety switches. The maximum workpiece height (calculated from the end of the fingertips) is dependent on the gripping width (w). For various width values the height (h) limit is given below:

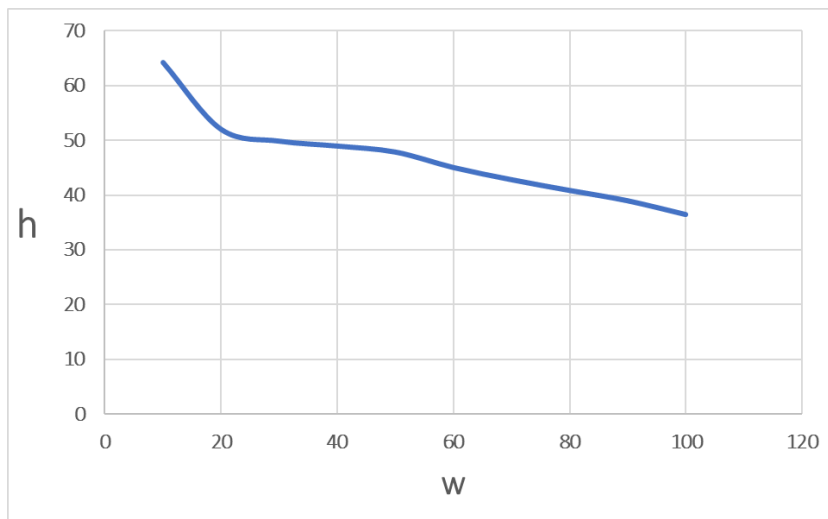

Fingertips

If custom fingertips are required, they can be made to fit the Gripper's fingers according to the dimensions (mm) shown below:

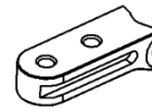
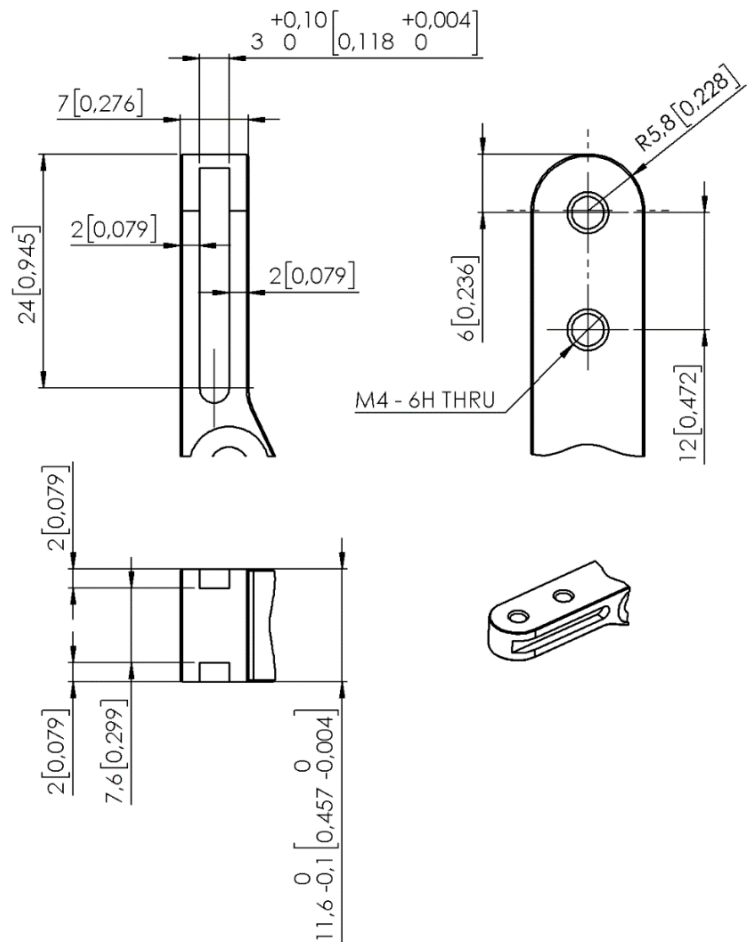
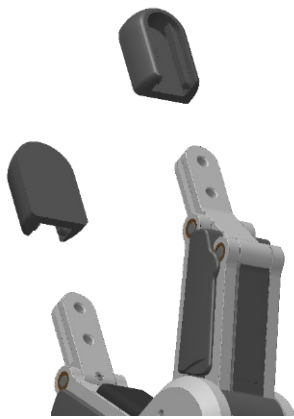

Standard fingertips

The standard fingertips can be used for many different workpieces. Standard fingertips improve the gripper's ability to pick and place different types of workpieces. The fingertip area of contact is made of rubber (EPDM) which increases the friction and reduces the probability of leaving marks on the workpiece.

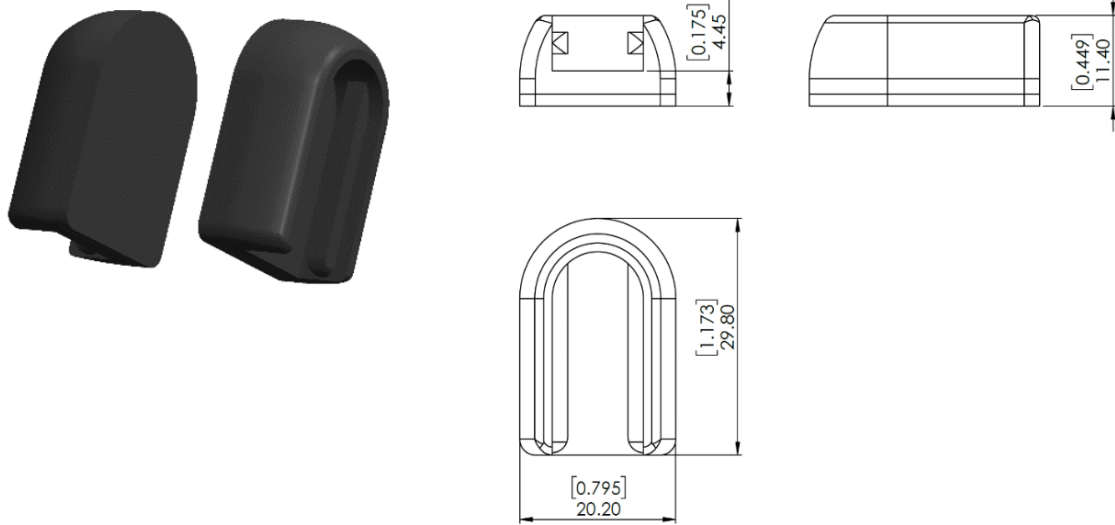

To purchase a new set of standard fingertips, please contact the vendor from where the RG gripper has been purchased.

- RG2 Fingertip Set PN 100669

X-Shaped fingertips

These fingertips improve the gripper's ability to pick and place cylindrical workpieces. By combining the force fit and the form fit gripping approaches, the fingertips increase the stability and payload of the workpiece to be gripped.

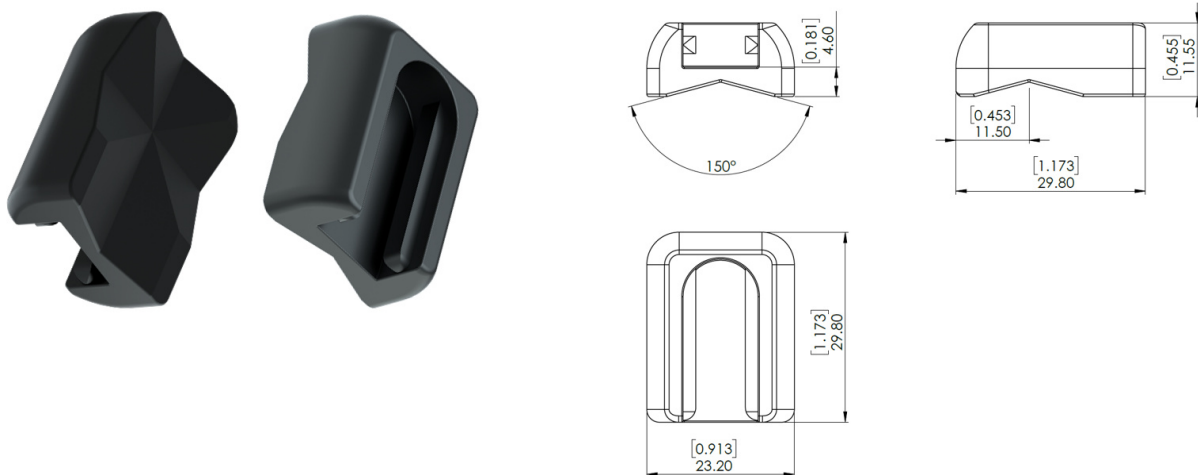

These fingertips are an accessory and need to be purchased separately. To purchase these fingertips, please contact the vendor from where the RG gripper has been purchased.

- RG2 X-Shape fingertips PN 105871

Fingertip extension 50 and 100 mm

These fingertips enable the gripper to pick and place workpieces in tight spaces where the gripper would normally be too wide, for instance boxes and crates.

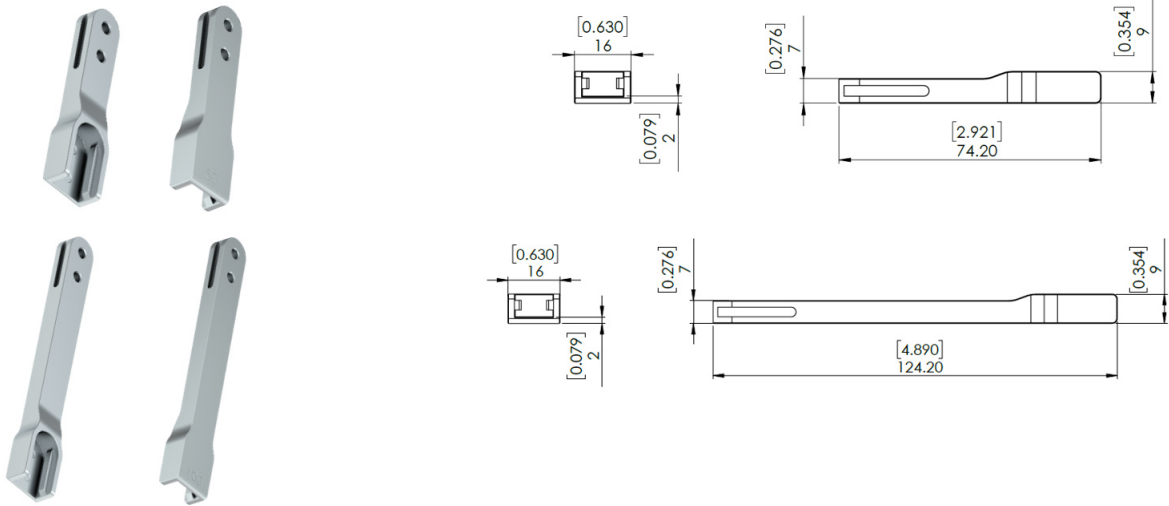

The extensions will decrease the gripping force:

- 50 mm - 66.67 % of target gripping force.
- 100 mm - 50.00 % of target gripping force.

These fingertips are an accessory and need to be purchased separately. To purchase these fingertips, please contact the vendor from where the RG gripper has been purchased.

- RG2 fingertip extension 50 mm PN 105872
- RG2 fingertip extension 100 mm PN 105873

1.2. RG2

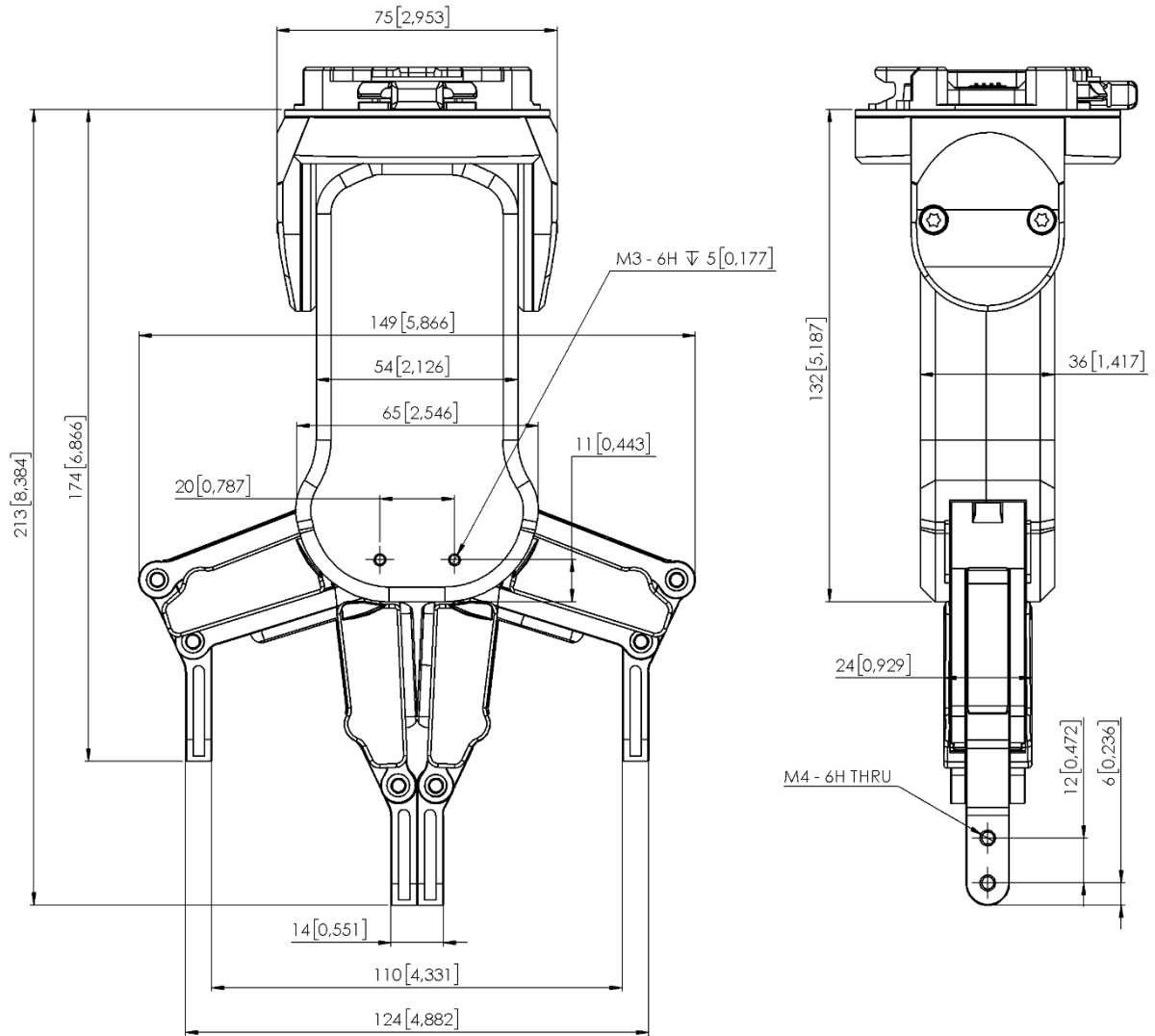

All dimensions are in mm and [inches].